

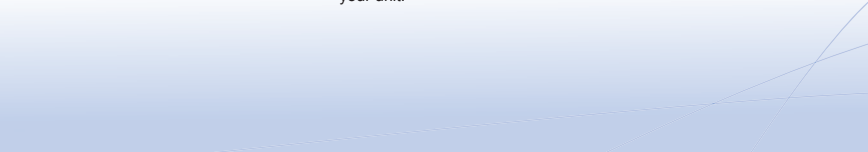

# Thuraya SatSleeve

## User Manual

Thank you for choosing the Thuraya SatSleeve!  
The SatSleeve allows you to use your iPhone in satellite mode. You can now enjoy calls and text messages even if your iPhone does not have a terrestrial network connection. The following User Manual contains important and useful information on how to use the Thuraya SatSleeve. Please read it carefully before operating your unit.



## Unpacking your SatSleeve

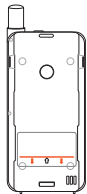

Main Satellite unit

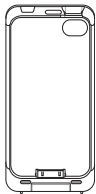

iPhone adaptor

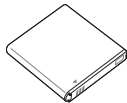

Battery



USB data cable

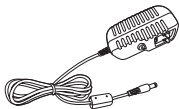

Universal travel charger

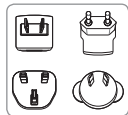

## Part Descriptions

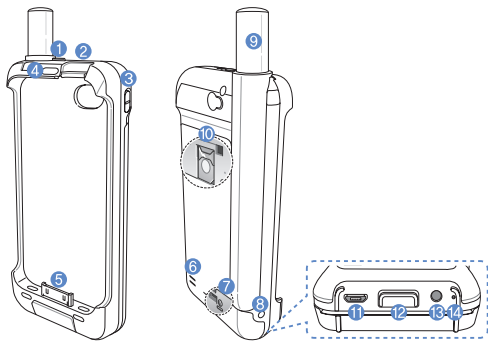

No.	Part Descriptions
1	Power On/Off button
2	Status indicator LED
3	Backup battery switch
4	Earpiece
5	iPhone docking connector
6	Loud speaker
7	Pairing button
8	Charger jack
9	Antenna
10	SIM card holder
11	Micro USB jack
12	Cradle lock
13	Earset jack
14	Microphone

## Preparation

The Thuraya SatSleeve uses satellite communications which requires direct line of sight to a Thuraya satellite. To achieve the best connection, please take care of the following:

- Use the SatSleeve in a place with no obstructions such as high buildings, tall trees, and mountains which may obstruct the line of sight with the satellite.
- In order to connect to the satellite network, the SatSleeve needs to receive the GPS location data first. This may take several minutes if the product is used in a new location.
- Always fully extend the antenna when using the SatSleeve for optimum connectivity.

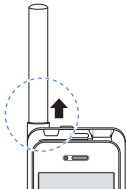

## Getting Started

### Installing the SatSleeve Application

In order to use the Thuraya SatSleeve with your iPhone, you need to download the Thuraya SatSleeve App for free from Apple's App Store. Please search for SatSleeve in the Apple App Store on your iPhone and install the application afterwards.



## Inserting the SIM Card

A SIM card is required to use satellite services when connecting to satellite network. Ensure to insert the SIM card before attaching the battery and turning on the Thuraya SatSleeve.

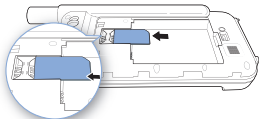

## Inserting the Battery

Remove the battery cover from the Thuraya SatSleeve by pushing it downward (1) and sliding it down (2).

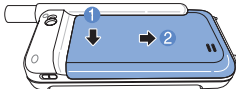

Insert the battery from the top end first. Once the battery is in place, reinstall the battery cover.

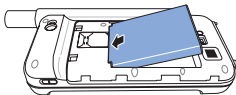

## Inserting your iPhone to the SatSleeve

- ① Attach your iPhone to the docking cradle pin and press the top side of the iPhone into the adapter.

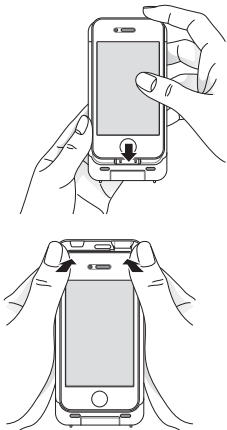

- ② Place the docking cradle onto the orange line of the SatSleeve main unit. Slide down the docking cradle.

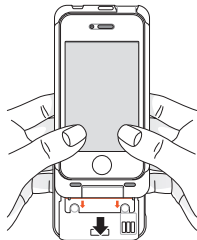

## Removing your iPhone from the SatSleeve

In order to remove your iPhone from the Thuraya SatSleeve, you first need to detach the docking cradle from the main unit. Once the docking cradle is removed, you can then remove the iPhone from the docking cradle.

- ① Press down the lock button until you hear a click.
- ② Slide up the docking cradle to detach it from the main unit.

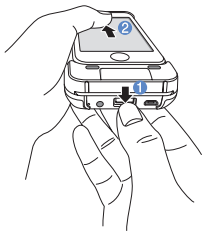

- ③ Gently bend the docking cradle backwards and pull out your iPhone.

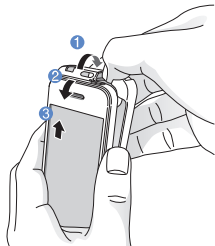

## Turning On the Thuraya SatSleeve

Press and hold the power button down for about 2 seconds to power on the Thuraya SatSleeve. The blue LEDs will blink and you will hear a beeping sound. The Thuraya SatSleeve is now ready to pair with your iPhone.

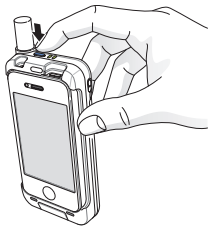

To turn off the SatSleeve, press and hold the power button down for about 2 seconds until all of the red LEDs are flashing and you will hear a beeping sound.

## How to use the SatSleeve

To enable satellite mode on your iPhone, you will need to pair your iPhone with the Thuraya SatSleeve via Bluetooth. Follow the below steps to pair the devices:

- ① On your iPhone, go to **Settings > Bluetooth > On** to activate Bluetooth on your iPhone.
- ② Select the SAT0000000 from the devices list.
- ③ Check the Bluetooth icon displayed on the top of your iPhone screen when the pairing is complete.
- ④ Open the SatSleeve application.





## NOTE

In case the two devices cannot be paired, press the pairing button on the back of the SatSleeve with a pointed object such as a pen or the end of a paper clip.

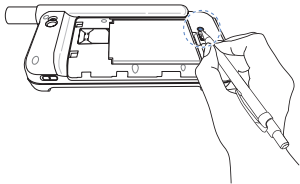

## Charging the Battery

### Charging the SatSleeve

Connect the plug of the charger on the bottom left side firmly.

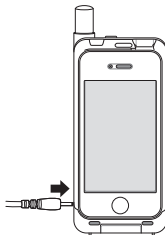

### Charging the iPhone Battery with the Thuraya SatSleeve

The Thuraya SatSleeve battery can be used to charge your iPhone battery when the iPhone is docked to the Thuraya SatSleeve.

To activate or deactivate battery charging of the iPhone, use the iPhone charging button on the right side of Thuraya SatSleeve.



## Overview of Home Screen



## Making a Call in Satellite Mode

On the Phone tab, you can enter a phone number directly, or select a phone number from your Contacts.

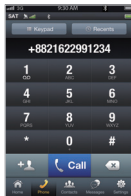

## Sending a Message

- 1 Select the tab **Messages**.
- 2 Enter a recipient's phone number or select the phone number from your Contacts.
- 3 Enter the message.
- 4 Tap **Send**.

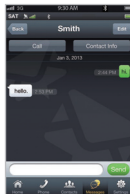
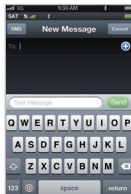

## Managing Contacts

When using the Thuraya SatSleeve application, you have access to all your contacts on your iPhone. If you create a new contact in the Thuraya SatSleeve application the contact will be saved on your iPhone.

### Creating a Contact

- 1 Tap **Contacts** at the bottom of the screen.
- 2 Tap **+**.
- 3 Enter the related information and tap **Done**.

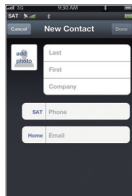
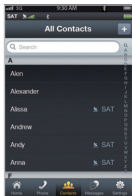

## Settings

### Basic

Adjust the settings for Calls, Messages, Bluetooth, and Sounds of your SatSleeve.

### Network

Select network options and network priorities.

### Security

You can activate and change PIN codes, Barring code and set a Closed User Group. Check the device information including SIM memory status, IMEI Number, Application version, RIL version, F/W version, and update the firmware if necessary.

## SOS Call without iPhone

The SatSleeve allows you to make and receive a call even if you don't have the iPhone with you. The SOS Call button is located between the main unit and the docking cradle.

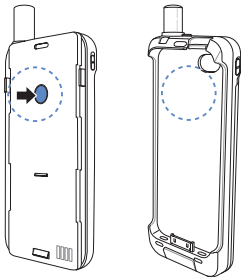

## Setting an SOS Number

- 1 Select **Settings** at the bottom of the screen.
- 2 Tap **Call > SOS number**.
- 3 Enter a phone number you would like to set as emergency number on the SatSleeve.
- 4 Tap **Done**.

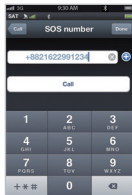

### NOTE

The SOS Button works even if there is no emergency number stored or if there is no SIM card inserted in the SatSleeve. In such a case, the call will be routed to 112 as a default (not available in all countries).

## Troubleshooting

Problem	Solution
Bluetooth pairing doesn't work.	Did you try pressing the pairing button? Please refer to the page 8.
Unable to eject the iPhone out of the cradle.	Did you separate the cradle from the main unit? In order to get your iPhone out, you need to remove the cradle first. Please refer to the page 6.
Unable to make/ receive calls.	Did you fully extended the antenna? Did you check if you have sufficient network coverage? Please refer to the page 4.
Unable to hear ringtones.	Did you run the SatSleeve application? In case the application is not running, there will be a vibration alert for incoming calls or messages.
The battery doesn't charge.	Did you check if the backup battery switch is off? If it is on, the iPhone battery will be charged instead of SatSleeve.
Phone shows Emergency Only	Did you check if the SIM card contacts are dirty or damaged? Your SIM card must be active and if you are abroad Roaming service must be enabled.
No Network	Please ensure you are in a place with no obstructions such as high buildings, tall trees, and mountains.
SatSleeve doesn't charge the iPhone even if the backup battery switch is on	If the SatSleeve battery is not sufficiently charged, it can't charge your iPhone. To charge the iPhone using the SatSleeve, the SatSleeve battery needs to be sufficiently charged or connected to the charger.

## Certification information (SAR)

### THIS DEVICE MEETS INTERNATIONAL GUIDELINES FOR EXPOSURE TO RADIO WAVES

Your wireless SatSleeve phone is a radio transmitter and receiver. It is designed and manufactured not to exceed the limits for exposure to radio frequency (RF) recommended by international guidelines (ICNIRP). These limits are part of comprehensive guidelines and establish permitted levels of RF energy for the general population. The guidelines include a substantial safety margin designed to assure the safety of all persons, regardless of age and health. The exposure guidelines for mobile devices employ a unit of measurement known as the Specific Absorption Rate or SAR. The SAR limit stated in the ICNIRP guidelines is 2.0 watts/kilogram (W/kg) averaged over ten grams of tissue. Tests for SAR are conducted using standard operating positions with the device transmitting at its highest certified power level in all tested frequency bands. The actual SAR level of an operating device can be below the maximum value because the device is designed to use only the power required to reach the network. That amount changes depending on a number of factors such as how close you are to a network base station. The highest SAR value under the ICNIRP guidelines for use of the device at the ear is 0.402 W/kg which was below the limit of 2.0 mW/g into a 10g averaging mass. Use of device accessories and enhancements may result in different SAR values. SAR values may vary depending on national reporting and testing requirements and the network band.

## FCC Compliance Statement

Your mobile device is also designed to meet the requirements for exposure to radio waves established by the Federal Communications Commission (USA) and Industry Canada. These requirements set a SAR limit of 1.6 W/kg averaged over one gram of tissue.

The Highest SAR value reported under this standard during product certification for use at the ear is 0.953 W/kg. Please only use your SatSleeve when adapter is docked to the main unit.

### CAUTION

This equipment generates or uses radio frequency energy. Changes or modifications to this equipment may cause harmful interference unless the modifications are expressly approved in the instruction manual. The user could lose the authority to operate this equipment if an unauthorized change or modification is made.

## RoHS

This product is in compliance with EU RoHS Directives and manufactured using lead-free solder paste and parts.

## Limitation of Liability

THIS LIMITED WARRANTY IS IN LIEU OF ALL OTHER WARRANTIES, WHETHER EXPRESSED, IMPLIED OR STATUTORY, INCLUDING, WITHOUT LIMITATION, THE IMPLIED WARRANTIES OF MERCHANTABILITY AND FITNESS FOR A PARTICULAR PURPOSE. THURAYA SHALL NOT BE LIABLE FOR DAMAGES IN EXCESS OF THE PURCHASE PRICE OF THE PRODUCT, LESS REASONABLE AMOUNT FOR USE AND WEAR, OR FOR ANY INCIDENTAL, SPECIAL, PUNITIVE OR CONSEQUENTIAL DAMAGES OF ANY NATURE WHATSOEVER, OR FOR ANY DELAYS, LOSS OF USE, TIME, PROFITS, REVENUE OR SAVINGS, ANY COMMERCIAL LOSS, INCONVENIENCE, MILEAGE, DAMAGE TO BUYER'S OR TO OTHER PERSON'S VEHICLE OR ANY OTHER PROPERTY, ARISING FROM THE USE OR INABILITY TO USE THE PRODUCT, OR OTHERWISE FOR ANY FAILURE TO PERFORM.

All liability and obligations of Thuraya under this Limited Warranty shall terminate upon the expiration of the applicable Warranty Period provided herein. This Limited Warranty sets forth the entire responsibility of Thuraya with respect to the Product. There are no other liabilities of Thuraya arising from the sale of the Product whether based on warranty, contract, negligence or other theories of liability. In no event shall Thuraya liability exceed the cost of correcting defects as provided herein. This Limited Warranty gives specific legal rights to Buyer, and Buyer also may have other rights which may vary from jurisdiction to jurisdiction.

CE 0983



Asia Pacific Satellite communications Inc (APSI) hereby declares that SatSleeve is in compliance with the essential requirements and other relevant provisions of Directive 1999/5/EC and EU RoHS Directives. The crossed-out wheeled bin means that within the European Union the product must be taken to separate collection at the product end-of-life. Do not dispose of these products as unsorted municipal waste.

THURAYA trademark is the sole and exclusive property of Thuraya Telecommunications Company.

Copyright © 2013 Thuraya Telecommunications Company. All rights reserved.

This manual is published by Thuraya Telecommunications Company without any warranty. Thuraya Telecommunications Company reserves the right to make changes and improvements to any of the products described in this manual without prior notice.